

Create...



CUSTOM OPTIONS CATALOG

Pacific Yurts, the original designer and manufacturer of modern lattice wall yurts, began constructing and selling yurts over thirty years ago. Many a skeptical eyebrow was raised in the early days as no one else in the world was doing it commercially. Now we raise only expectations as new and existing customers come back to us again and again with praise and referrals. We are proud of their trust and loyalty, earned through our commitment to the highest quality craftsmanship and materials, on-time delivery, and customer service.

For over three decades we have built yurts as our sole product line. We have listened to and worked with thousands of customers worldwide enhancing our yurts to meet their needs. Our experience and the proven performance of the Pacific Yurt in many unique situations assure you of an exceptionally high level of customer satisfaction. Simply put... **No One Knows Yurts Like Pacific Yurts.**

Our tradition of innovation is continued with the introduction of the options included in this Custom Options Catalog. Each element within this catalog was designed and developed exclusively by Pacific Yurts to assist you in creating your own space.

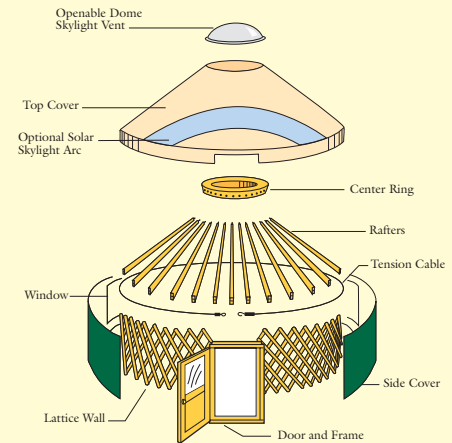

CONTENTS

	<i>page</i>
Side Cover Options	3
Insulation Options	3
Door Options	4
Top Cover Options	4
Lattice Wall Options	6
Snow and Wind Options	7
Dome Options	7
Center Ring Options	8

"We want to thank you for making this adventure a pleasant one! It is truly a pleasure to work with such a professional company that is so interested in their customer's satisfaction."

Earl and Kathy Davis, North Carolina



As you walk between our display models and manufacturing facility, you'll cross a small stream meandering through a carefully preserved grove of 100 year old oak trees. We have "naturescaped" around our production shop and office and installed bird boxes from the Oregon Department of Fish and Wildlife. We invite you to visit.

If you are already the proud owner of a Pacific Yurt, you can add many of the options yourself. Other options are available only with a new purchase.

SIDE COVER OPTIONS

Side Cover

Our standard Side Cover, made of high quality 100% woven polyester fabric, provides exceptional strength, durability and low maintenance. Optional Vinyl Side Cover is also available. Proven performance of both fabrics assures you of long lasting value. There are many custom colors to choose from such as Forest Green or Terra Cotta. Fabric swatches are available.



Additional Windows

Windows can be located around the perimeter of the yurt, to take advantage of a view and coordinate with your interior layout. They also furnish additional light and ventilation, adding to the spacious open feeling of the yurt. They're made of extra strong, clear vinyl, framed in tear-away Velcro and include zippered weather flaps and sewn-in screens. Which means mosquitoes stay out.



Window Awning Frame

The Window Awning Frame consists of an anodized aluminum framework to support the window flap. This creates an overhang allowing the windows to be left open for ventilation.



Custom Curve™ Glass Window

Our Custom Curve window system is truly unique. It features an openable, energy efficient glass window mounted into a structurally engineered curved frame to match the circular shape of the yurt.

This innovative design avoids the “flat panel” look, and our exclusive fabric flange assures a weather tight seal. Order

with a new yurt or retrofit to your existing Pacific Yurt. Customize with your own finishing touches such as shelving, blinds or curtains. Includes trim kit and removable bug screen. Available on 20', 24' and 30' yurts.

INSULATION OPTIONS

Insulated Window Covers

These covers are made of reflective insulation with a fabric liner facing to match the interior insulation of your roof and sides. These will insulate your windows during the coldest times of the year and are easy to attach and remove. It's like a pair of long johns for your window. Consider insulating some windows while leaving others uncovered for light and view.

Insulation Liners

If it's good enough for astronauts in space, you'd better believe it will help keep you warm here on Earth. Our seven-layer reflective insulation was developed by NASA. We cover it with an ivory colored fabric for an attractive interior finish. An ideal vapor barrier, it works by reflecting radiant heat in both directions, keeping the yurt warmer in the winter and cooler in the summer. It is custom designed to match your window and door placement.



DOOR OPTIONS



Standard Panel Door and Frame

This high quality Douglas fir door with inset wood panels comes pre-hung in a frame laminated for extra strength. We custom make it here in our own shop, treat it with a penetrating oil for a stunning natural finish and add a quality locking lever. Because sometimes you'll want to keep others out and have the whole place to yourself.

Window Door

It has all the strength and beauty of our panel door and features a large Plexiglas window. This inviting entryway provides additional light and a broader view. Who wouldn't want that? Also available with windows at the top and bottom. (Double Window Door)

French Doors

You can almost see the Seine when you look out through these doors. They're hand-built right here in our shop and are truly elegant with wood panels at the bottom and strong durable Plexiglas windows. They architecturally enhance the design of any yurt with a wider access and additional view. They're available for the 16' yurt and larger models.

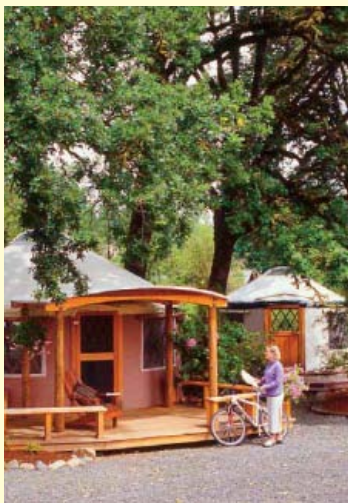

Screen Door

Beautiful vertical grain Douglas fir screen door includes self-closing hinges and heavyweight screen. Provides extra ventilation while keeping the bugs out.

Upgrade Hardware for Screen Door

This option upgrades the standard spring-loaded steel screen door hinges to solid brass butt hinges. Also included is a pneumatic door closer.

Extra Door and Frame

Add a back or side entrance for easy access to decks, hot tubs, gardens or additional views. Available on 16' and larger yurts. Ask about placement options.

Door Screen Curtain

Open your door and let in the fresh air, but not the bugs! The Door Screen Curtain attaches to the top inside of the door frame and is weighted at the bottom. Keep insects outside where they belong!

TOP COVER OPTIONS



Rain Diverter

Our Rain Diverter is a professional at diverting rain water away from the entry. This inverted V-shaped fabric pouch is welded to the roof and has PVC inserts for rigidity adding an attractive touch to your entryway. It also provides an attachment for a future Door Awning or Door Canopy.



Door Awning

Our versatile Door Awning is a 5' x 6' piece of roofing fabric welded over the door. Add your own wood or metal support and the awning becomes a covered porch for outdoor enjoyment and shelter from the weather. The awning can also serve as a transition roof to connect one yurt to another. Custom awnings in additional sizes are also available. And like an umbrella, the awning folds up when not in use.

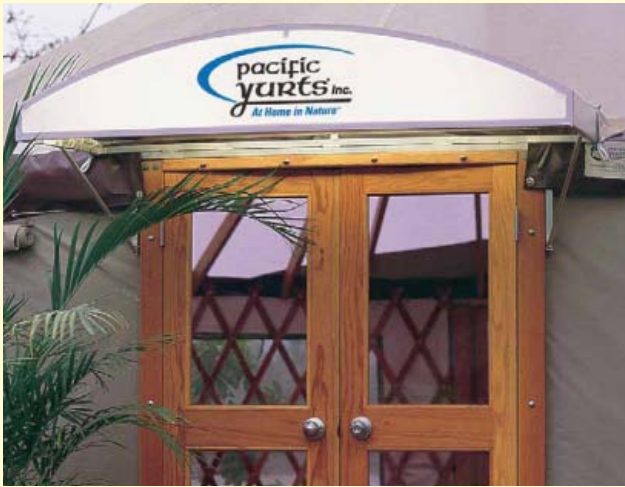

Door Canopy

The Door Canopy provides a graceful entry to your yurt while protecting the entryway from rain. It is made of top quality vinyl fabric on a welded aluminum frame. To personalize your yurt, add custom graphics, your logo or name to the front, along with a backlight system with translucent fabric. You and your guests will enjoy the practicality and elegance of this architectural feature.

“I am pleased to see that your yurts are continuing to evolve with new options like porch awnings and water catchments. As I head into my fourth Colorado winter in my yurt, I’m still in awe of the beauty and functionality of my home.” Brett A. LeCompte, Colorado

Top Cover

Our standard flame retardant vinyl Top Cover provides excellent durability, low maintenance and protection against the elements. This extended life structural fabric is ideally suited for extremely wet climates or where snow loads are encountered. Overhead seams are electronically bonded together instead of being machine sewn and are impervious to moisture.



Solar Skylight Arc

If you thrive on an abundance of natural light, the Solar Arc is the answer to your dreams. This durable, translucent vinyl roofing fabric allows diffused light to bathe the interior of your yurt. It takes advantage of natural lighting and is perfect for artists’ studios and remote locations without electricity. Recommended for moderate climates. Available in the standard Top Cover only.

Heavy-Duty Top Cover

This top is made of the highest quality roofing fabric available. It carries a 15-year material manufacturer’s warranty. This is the same roofing material used on many new commercial buildings. Available in tan, white or gray.

Not for use with the Solar Skylight Arc.

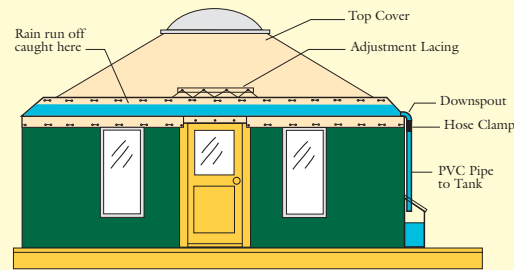

Water Catchment

You don’t have to be marooned in the Sahara to understand the importance of conserving water. Our system, engineered for conserving rainwater, is a fabric gutter that collects run-off from the roof, funneling it through downspouts into a storage tank or cistern system which you supply. Available on new top only. For non-potable water use.

“I enjoy the Pacific Yurt very much with my friends and family. It is a sacred space that I really cherish. Thanks for making it possible.”

Missy Giove, World Cup Downhill Mountain Bike Champion, Colorado



Perimeter Gutter System

This Gutter System not only collects water run-off from the roof, but also prevents it from running down the wall. This will keep the Side Cover cleaner and dryer, reducing maintenance. Similar function to Water Catchment System but utilizes rigid PVC and can be retrofit. Not recommended for high snow areas.

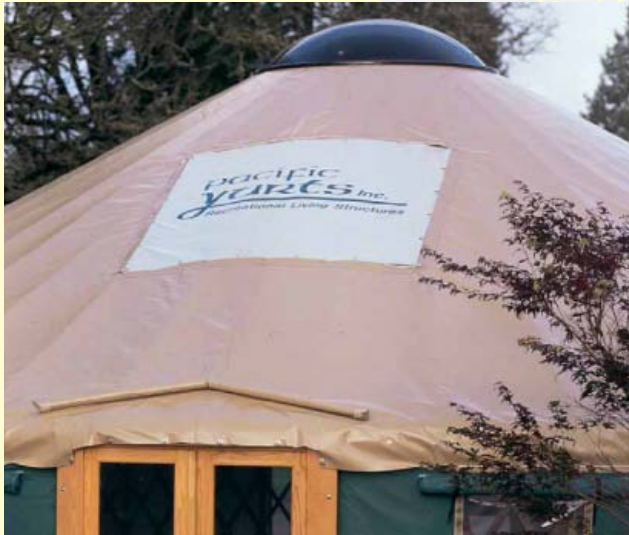

Banner System

If you have something to say and you want everyone to know about it our Banner System offers you a great opportunity. You can display custom graphics or logos on your yurt for commercial enterprises or to identify sponsors for special events. The removable banner laces into a grommeted frame mounted on the roof.

Stove Flashing

The stove flashing is a double metal flashing that allows the stovepipe to exit through the side cover. Flashing is made from galvanized sheet metal that is powder coated for corrosion resistance and beauty. The standard opening is 8" – other sizes are available.

“The Nike Outdoor Sports Marketing department used a Pacific Yurt to create an on-site presence for World Cup Mountain Bike Races and for the Summer and Winter X Games. It offered shelter to our athletes and staff in the pouring rain, blazing sun and freezing mountain conditions. The Nike yurt was easily recognizable and well received by our consumers and athletes. It was a sweet setup!”

Margie Wargo, Nike Outdoor Sports Marketing, Oregon

LATTICE WALL OPTIONS

Tall Wall

If you plan to add a loft or if you or your guests come in tall sizes, the Tall Wall option is for you. It raises the wall height of your yurt to approximately 7' which naturally provides a taller entrance and a more spacious interior. Standard height is 6'.

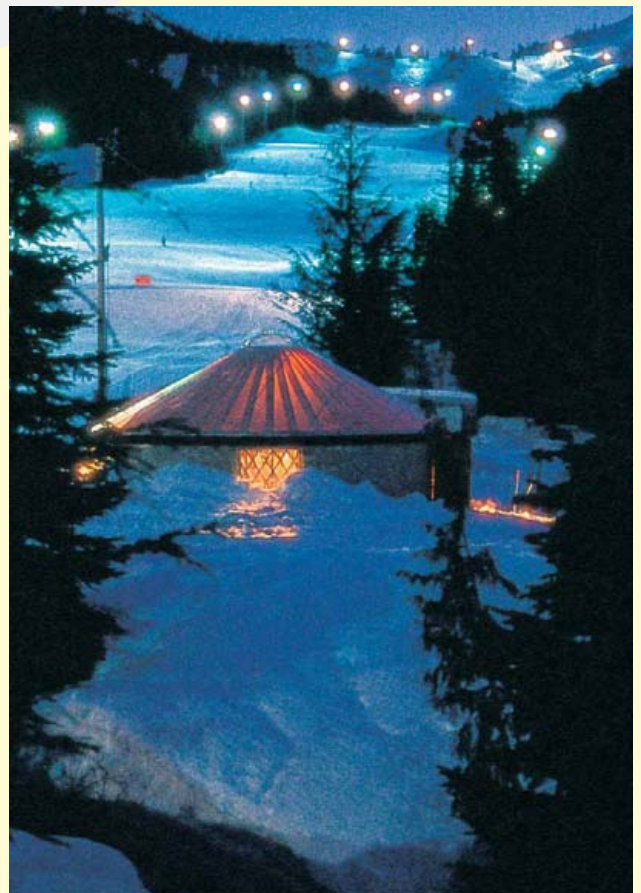

SNOW AND WIND OPTIONS



Snow and Wind Kit

If the terms “snow expected to ease up next week” and “high-wind warning” are a part of your daily weather report, this Kit is an answer to your concerns. We specifically engineered it for

heavy snow and high wind conditions and it has proven its strength on the Oregon Coast, in Alaska and at many ski resorts. The Kit consists of high quality, kiln-dried supports secured by our custom hardware, and a cable blocking system to add rigidity to the roof. For higher snow load requirements, see our Central Column System. Stainless Steel Hardware upgrade available for harsh marine environments.

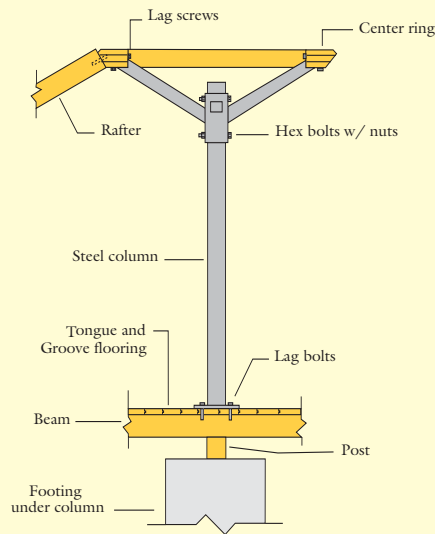

Central Column System

This System upgrades your rafters, rafter supports, center ring and hardware and adds a steel column support. Ideal for larger yurts in high snow or wind conditions, such as at ski resorts, or where engineered high snow load capacity is required.

“Pacific Yurts work great for us here at Sundance. We have recently had two winters of the heaviest snow and wind I can remember and the yurts’ performance was bullet proof. Our guests are blown away by the aesthetics and comfort of our yurts.”

Sam Palmatier, Sundance Resort, Utah

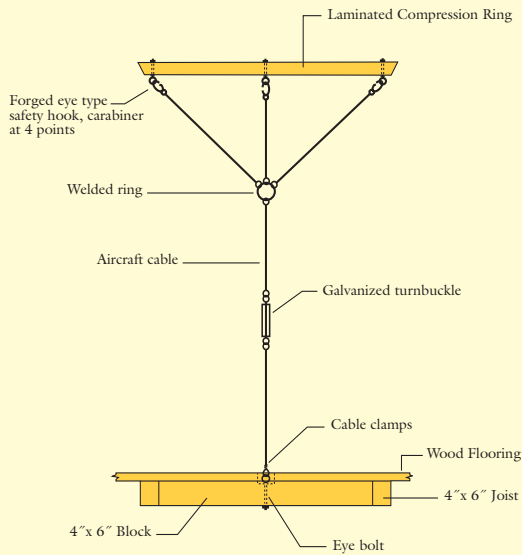

Cable Tie-Down System

You might own a four-wheel drive, and still carry chains. This option provides that additional level of protection in high winds. The System secures the center ring to the floor and is easily installed and removed as needed for severe wind conditions or when your yurt will be unoccupied for long periods. Designed to be used in conjunction with our Snow and Wind Kit.

DOME OPTIONS

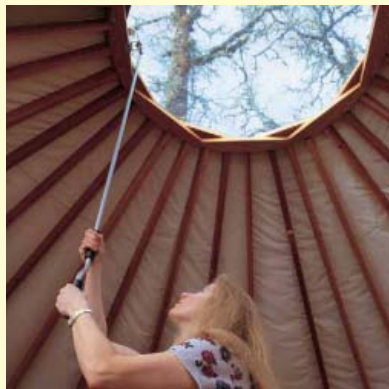

Dome Opener

It’s a little like a sunroof in your car. Sometimes you’ve just gotta open it. Opening the dome skylight allows the escape of hot air that may get trapped at the ceiling. Creates a natural convection

cooling system for refreshing comfort. For further air movement, add a ceiling fan with our Fan Support.

Tinted Dome Skylight

Highly recommended for those of you who live in the tropics or have a site in a hot location with direct sun. The Tinted Dome blocks approximately 60% of the heat that comes through the skylight, and only marginally affects the natural light. So you’ll have a clear view of the heat that isn’t there.

CENTER RING OPTIONS



Center Ring Insert

Our finely crafted wood frame fits into the center ring and comes with your choice of optional bug screen or shade screen. The bug screen provides a barrier against

insects, and the shade screen provides a thermal barrier. Designed for easy removal.



Fan Support

Though it may seem so, this isn't your own little gallery of cheerleaders. This sculpted wood support allows you to use a ceiling fan in your yurt to keep things cool. Additionally, most fans can be reversed to aid heat circulation during the cold months.



Tropical Cupola

Designed for hot tropical environments, this powder-coated steel frame has an architectural fabric cover and replaces the dome skylight. The cupola is raised 6" around the perimeter, provides shade and

creates a natural cooling system by allowing maximum air flow for refreshing comfort.



US Senate Productivity Award
SBA Exporter of the Year Award-Oregon
SBA Exporter of the Year Award-Region 10

© 2011 Pacific Yurts Inc. All rights reserved. Patented Pacific Yurts Inc. holds domestic and international exclusive rights in its intellectual assets under copyright, trademark, and patent law.

Printed on recycled paper with soy inks.

From coastal beaches to alpine slopes, from tropical rainforests to desert country, your Pacific Yurt goes wherever your imagination takes you. We look forward to helping you create your own space.



CONTACT US



Color brochure and price list available upon request.

Call for more information or phone, fax, mail or email your order today.

Phone 541.942.9435
Fax 541.942.0508
Toll free order line 1.800.944.0240
Email: info@yurts.com

www.yurts.com

Pacific Yurts Inc.
77456 Highway 99 South
Cottage Grove, Oregon 97424, USA