

Platform Construction

Being what we call a ‘soft’ structure, the yurt reacts more readily to climatic conditions than do ‘rigid’ structures, therefore it is important to choose your site carefully and take into account prevailing wind patterns, overhead tree limbs, water runoff, etc. In general, the best site would be protected from the wind, would receive morning sun and afternoon shade and be free from overhead objects such as large dead tree limbs that could damage the yurt in heavy winds. Plan your entry so that the doorway faces away from prevailing winds.

For a secure and comfortable installation, a well-built platform is necessary. To ensure a weather proof installation the platform needs to be circular and the same diameter as the yurt so the side cover fabric can extend below the interior floor level. This will provide a draft-free and watertight seal. Any exterior decking should be separated from, or at a lower level than the yurt platform. Unless you are skilled, enlist the help of an experienced carpenter for building the platform.

The following plans show the typical construction of the yurt platform. Keep in mind that every site will be different, so the platform construction and footings should reflect the conditions of each individual site.

Notes:

- 1.) The bottom portion of the drip edge will be visible once the yurt is installed. It should be stained or painted to match the exterior color scheme.
- 2.) The 1" portion of the drip edge that extends above floor level will be visible on the inside and can be painted or stained to match the interior color scheme.
- 3.) Plywood skirting (to prevent airflow beneath the floor) and a vapor barrier may also be desirable.
- 4.) If you plan to connect the yurt to an existing building (or another yurt) be sure to allow a minimum of 12" between the existing building and your yurt platform. A covered walkway can be built to connect the two after the yurt is installed.
- 5.) Keep in mind that the windows open from the outside. If you plan to have the platform elevated you should consider adding a catwalk or exterior decking for window access.
- 6.) If you plan to install a “floating” floor on your platform, please contact Pacific Yurts for recommendations on how to prepare the platform.
- 7.) When using the 2x6 T&G flooring be sure it is kiln dried and has a low moisture content to avoid gaps as the wood dries.

The original designer and manufacturer of the modern yurt, leading in quality and service for 30 years.

77456 Hwy. 99 S. • Cottage Grove, OR 97424 • (541) 942-9435 • FAX (541) 942-0508 • E-mail: info@yurts.com

Platform Construction Overview

1.) Lay out pier blocks according to framing plan and level.

Note:

- Poured concrete footings may be substituted for pre-cast pier blocks.

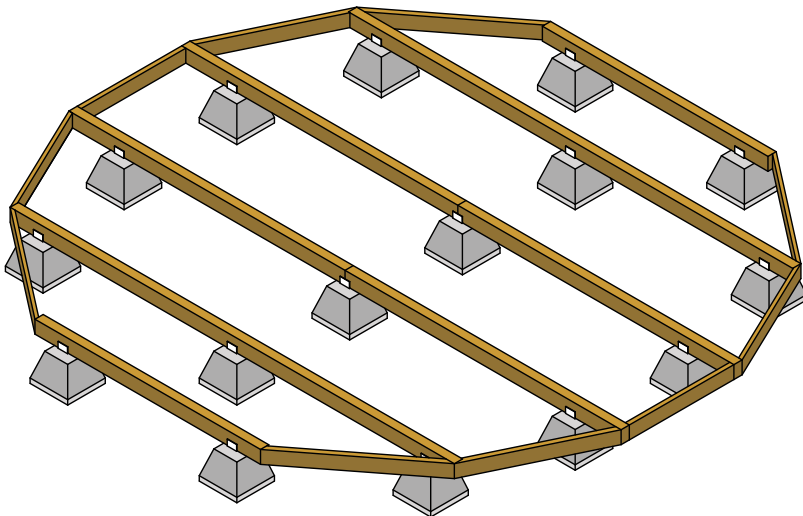
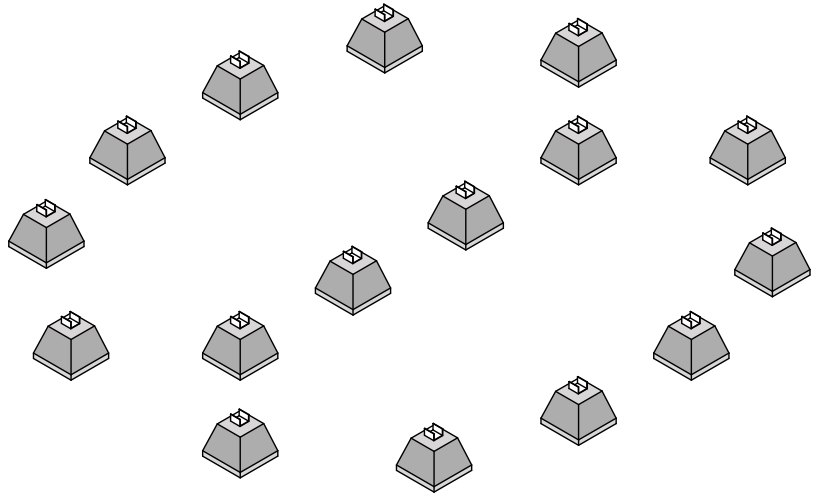

2.) Cut 4x6 beams to length, level them, and fasten onto pier blocks.

3.) Cut 2x6 perimeter blocking and fasten to 4x6 beams.

4.) Install floor insulation (optional).

Notes:

- Diagram assumes level site. On sloping terrain vertical support posts and cross bracing may be necessary.
- If 1/8" plywood flooring is used we recommend adding 2x6 blocking between beams (four feet on center).
- If you plan to purchase the cable tie-down option an extra 4x6 block will be needed in the center of the platform.

5.) Fasten flooring (1/8" plywood or 2x6 T&G) onto 4x6 beams.

6.) Cut flooring into circle with diameter matching that of the yurt.

7.) Staple 2" wide strips of tar paper onto edge of cut flooring (or use caulking) to provide a seal between flooring and drip edge.

8.) Cut 3/8" exterior plywood (OSB is best for small yurts) into strips of desired width (at least 8") and fasten around perimeter of flooring so that 1" protrudes above floor level. This is the plywood drip edge.

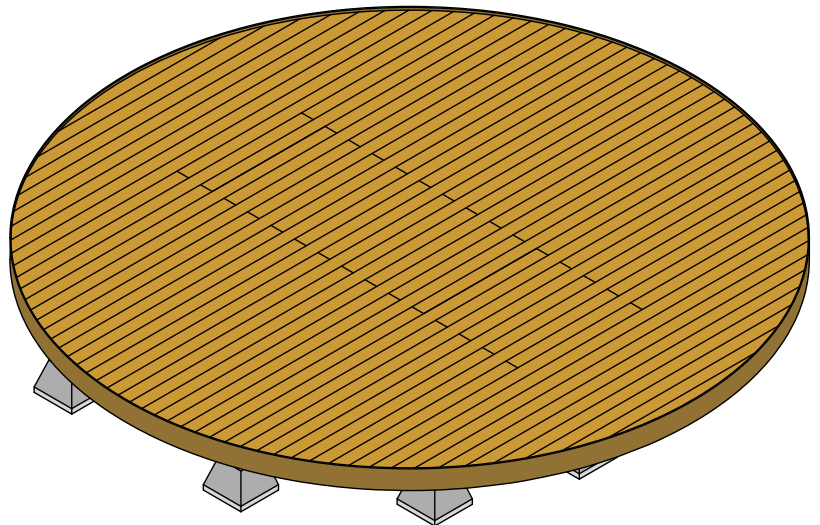

Typical 20' Platform Framing Plan

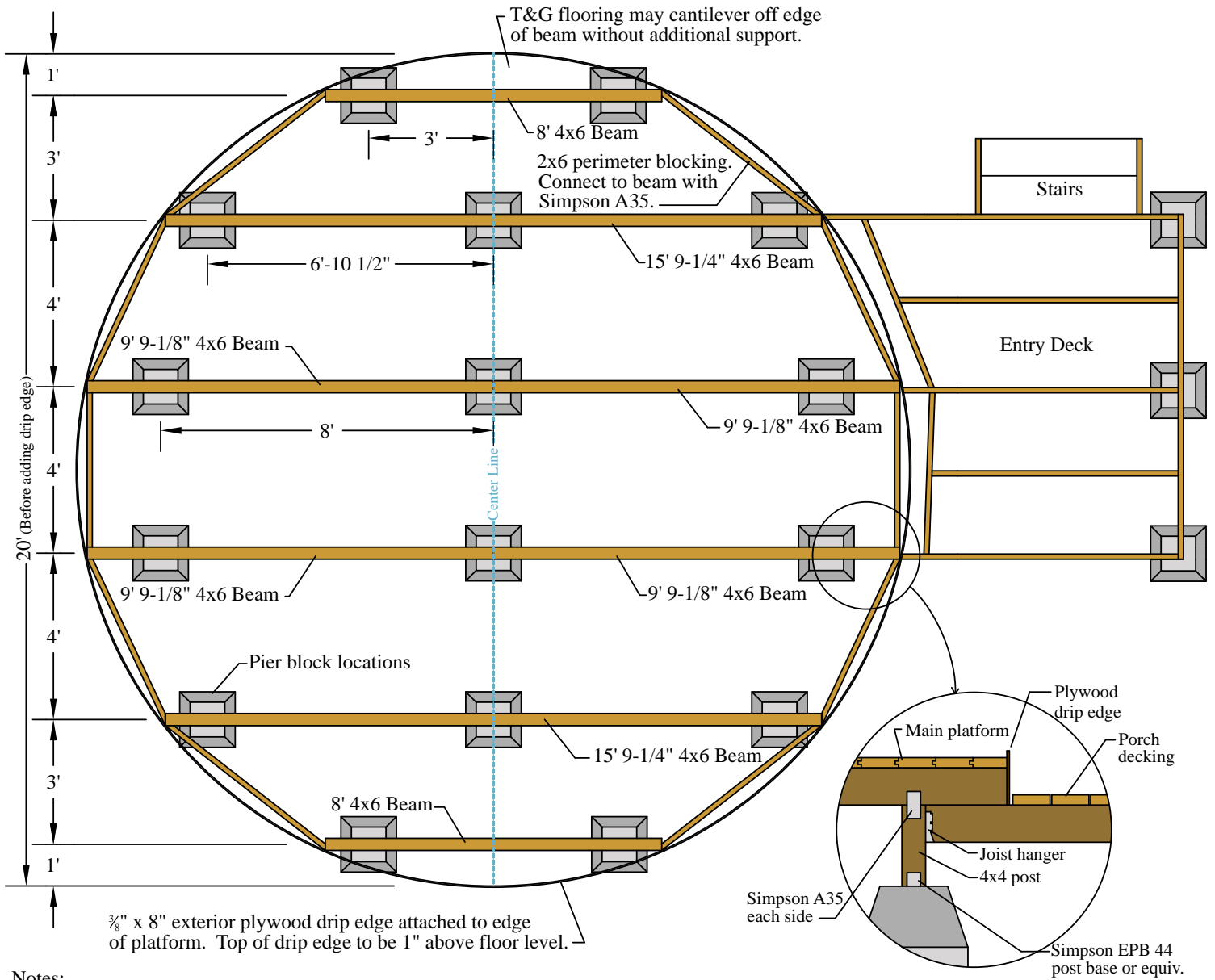

Notes:

- 1.) Platform construction and footings should reflect conditions of each individual site.
- 2.) 2x6 T&G or 1 1/8" plywood flooring to be laid perpendicular to 4x6 beams and trimmed to the same diameter as that of the yurt.

TYPICAL ELEVATION

Entry deck should be below the floor level of the yurt platform so as not to interfere with drip edge.

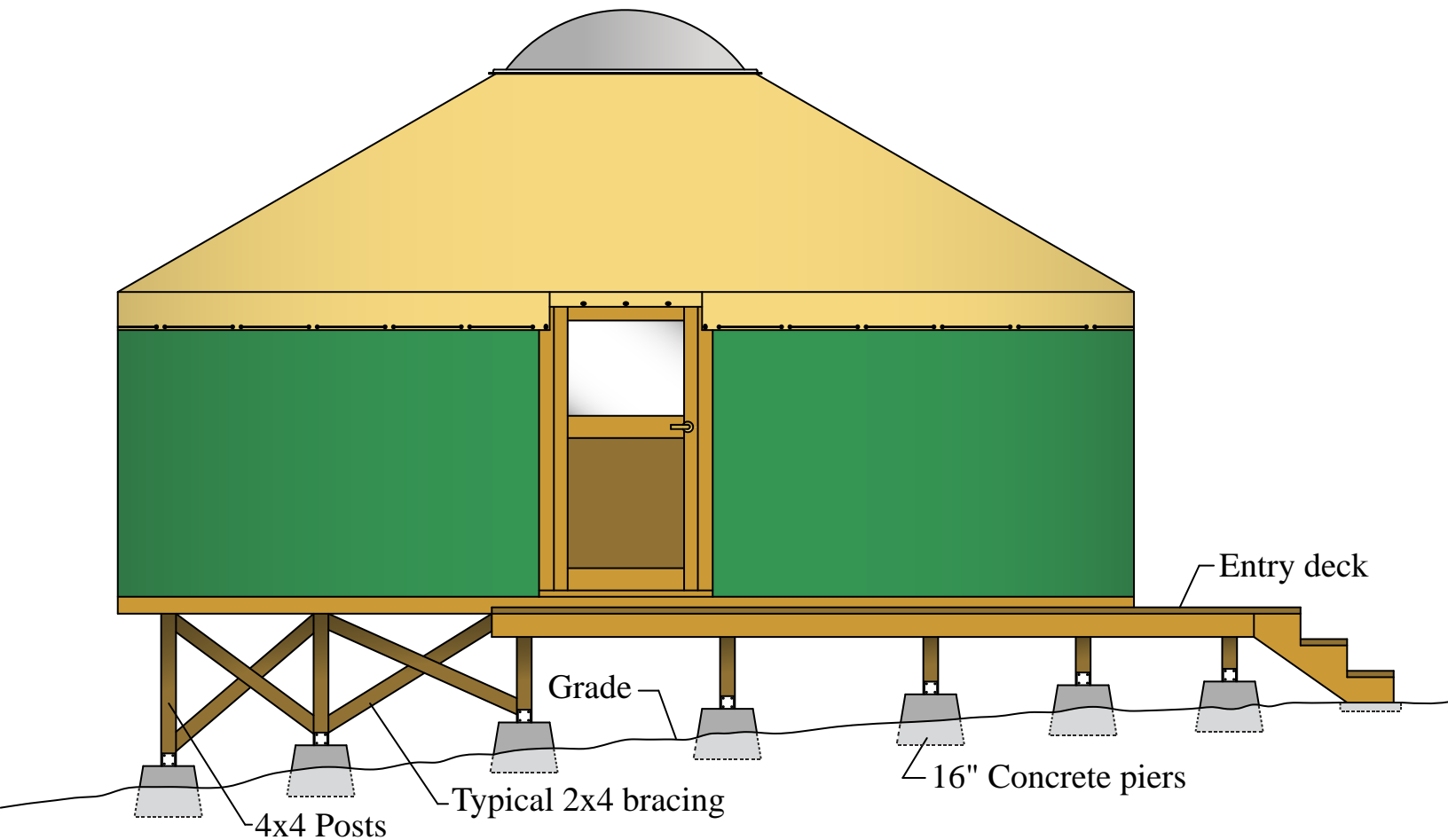

Note: Platform and footings should be designed according to the conditions of each individual site and local building requirements.

Typical Platform Elevation

2x6 T&G Layout - 20' Yurt

Often 2x6 T&G is used for open beam ceilings and may have a V-groove which should face down so as not to catch debris and make floor sweeping difficult.

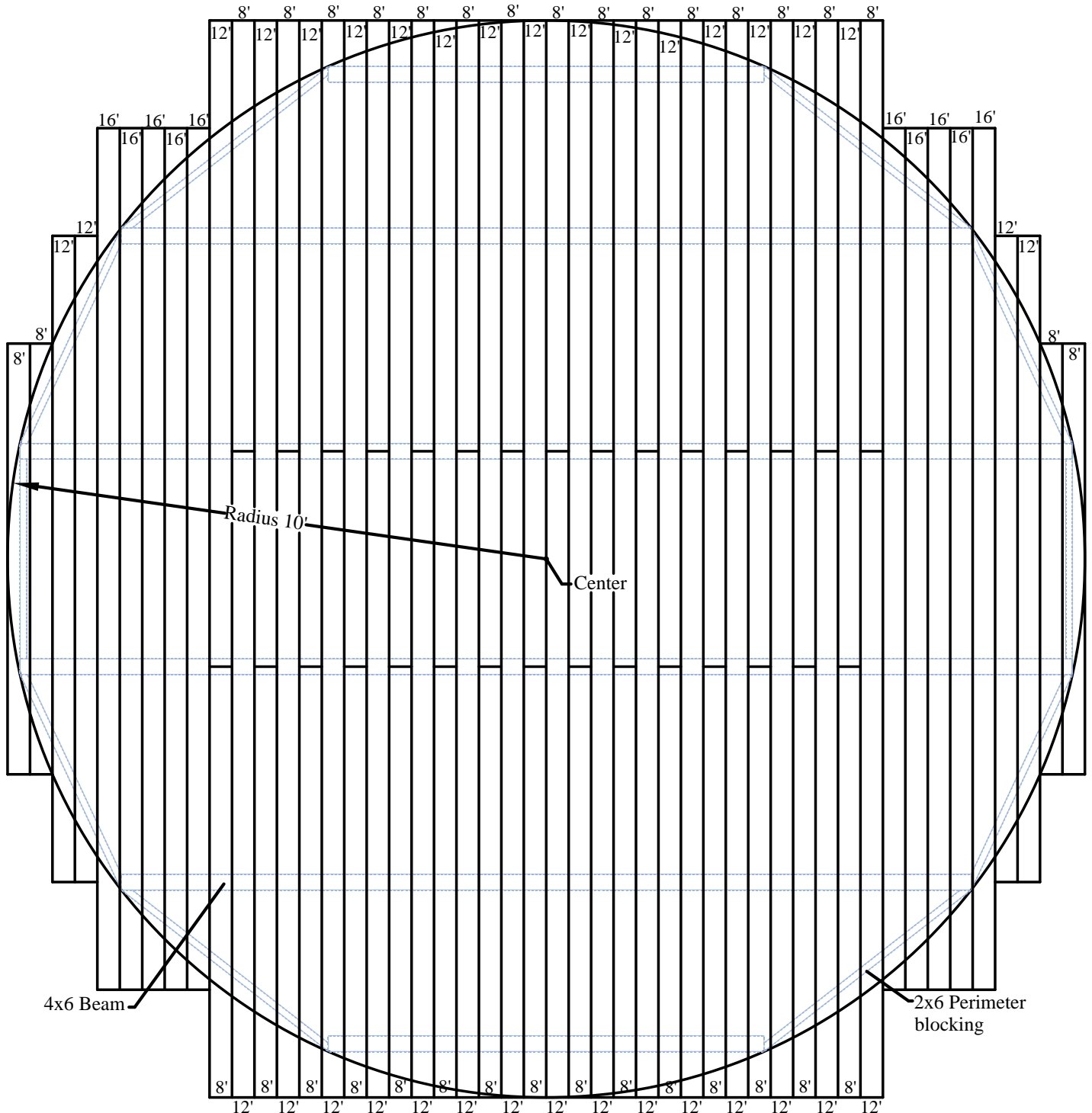

1.) Make a compass using a board or non-stretch string and a nail at the center to mark radius.

2.) Using a sharp circular saw carefully cut the platform to exactly 20 feet in diameter.

Plywood Layout - 20' Yurt

Note: Due to the tongue and groove on 1-1/8" plywood you may need to laminate a small piece of scrap to one edge in order to achieve the full diameter.

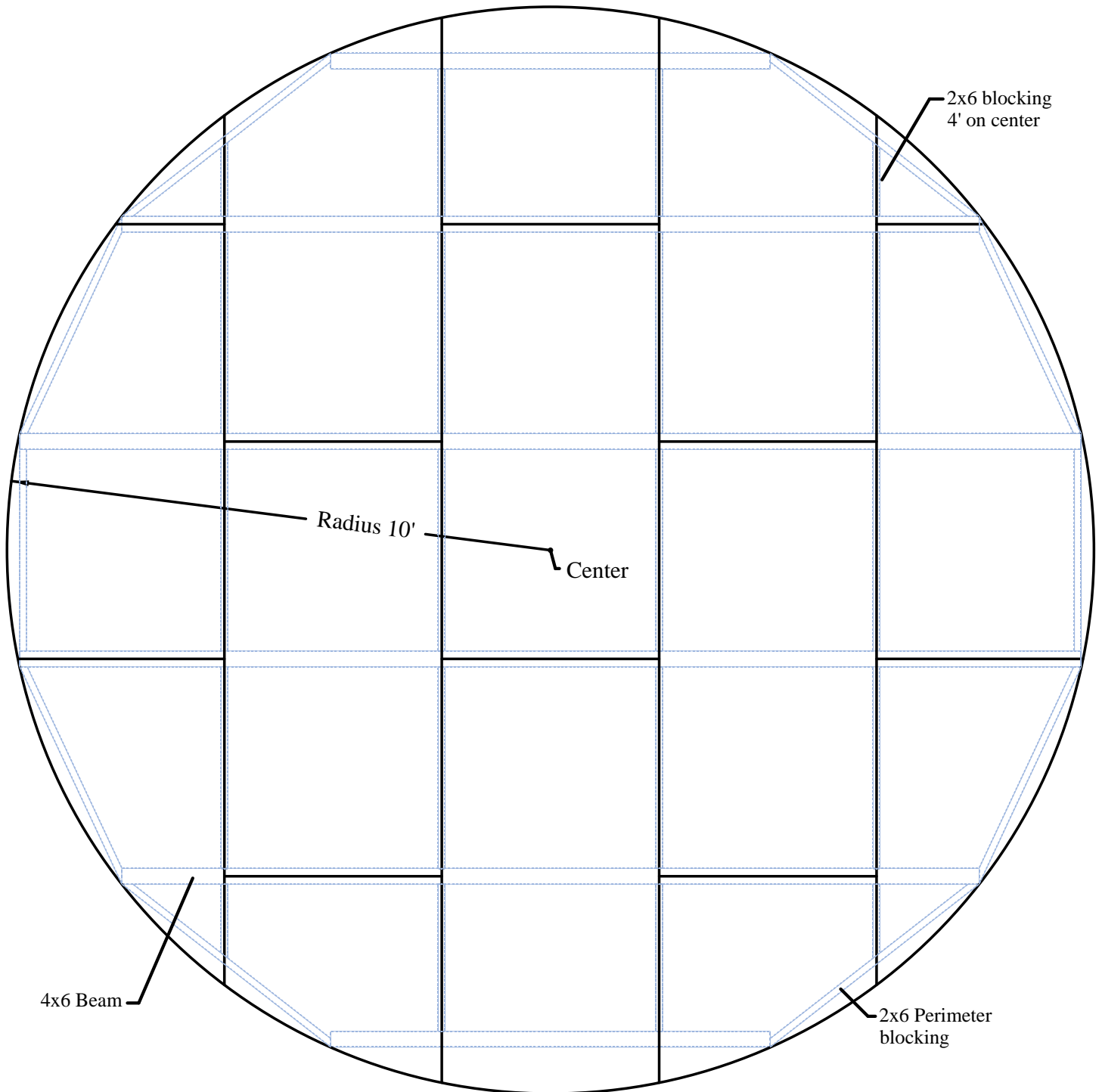

1.) Make a compass using a board or non-stretch string and a nail at the center to mark radius.

2.) Using a sharp circular saw carefully cut the platform to exactly 20 feet in diameter.

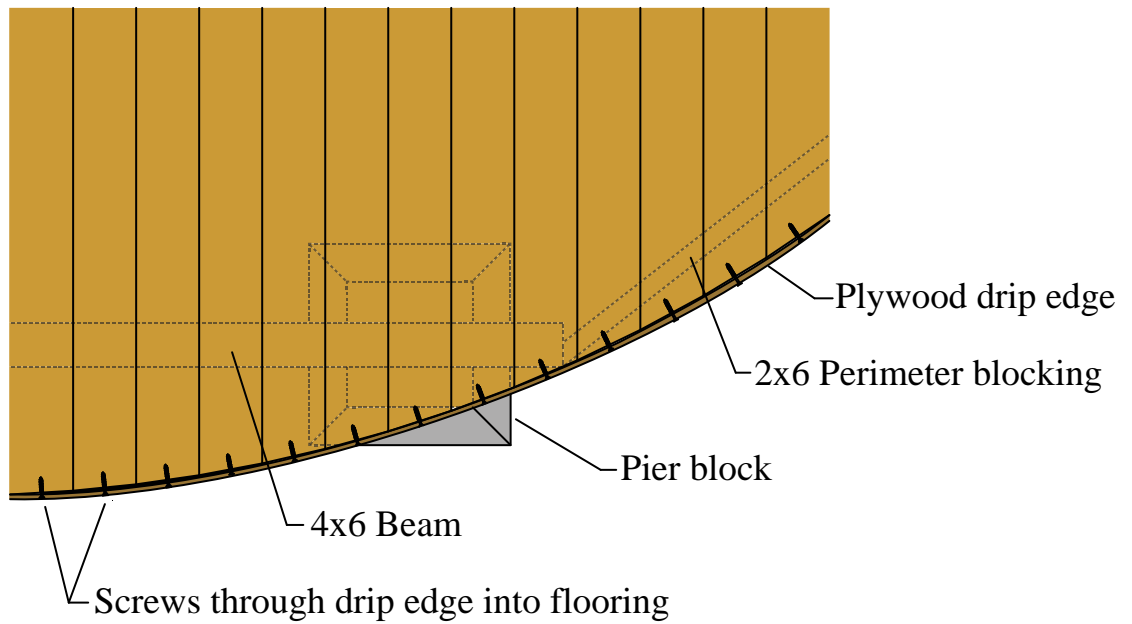

Plan View

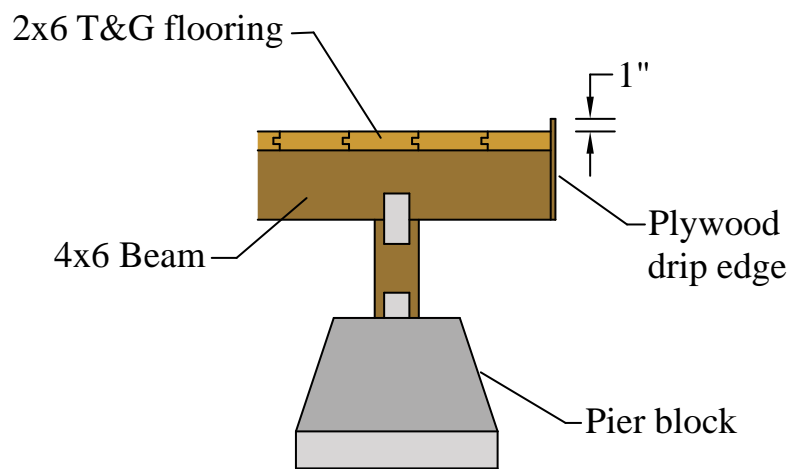

Elevation

20' Diameter Yurt		
Platform Materials – 2x6 T&G Flooring Option		
Material	Quantity	Use
2x6 Kiln Dried T&G 'Select Deck'	27 @ 16' 34 @ 12'	Platform Flooring
2x6 Standard & Better	4 @ 10' 1 @ 8'	Perimeter Blocking
4x6 Standard & Better	2 @ 16' 4 @ 10' 2 @ 8'	Beams
3/8" Exterior Plywood Siding (no groove)	2 Sheets (4' x 8')	Plywood Drip Edge
16" Concrete Pier Block with Post Base Bracket	16	Footing

20' Diameter Yurt		
Platform Materials – 1-1/8" Plywood Flooring Option		
Material	Quantity	Use
1-1/8" T&G Plywood	12 Sheets (4' x 8')	Platform Flooring
2x6 Standard & Better	6 @ 10' 7 @ 8'	Blocking
4x6 Standard & Better	2 @ 16' 4 @ 10' 2 @ 8'	Beams
3/8" Exterior Plywood Siding (no groove)	2 Sheets (4' x 8')	Plywood Drip Edge
16" Concrete Pier Block with Post Base Bracket	16	Footing

Note: This material list represents the minimum amount of lumber, etc required for a basic circular platform on flat level ground. It does not include any exterior deck/porch materials. For sloped sites or to elevate the platform you will need to add 4x4 posts and cross bracing.