

# 12' Platform On Existing Deck

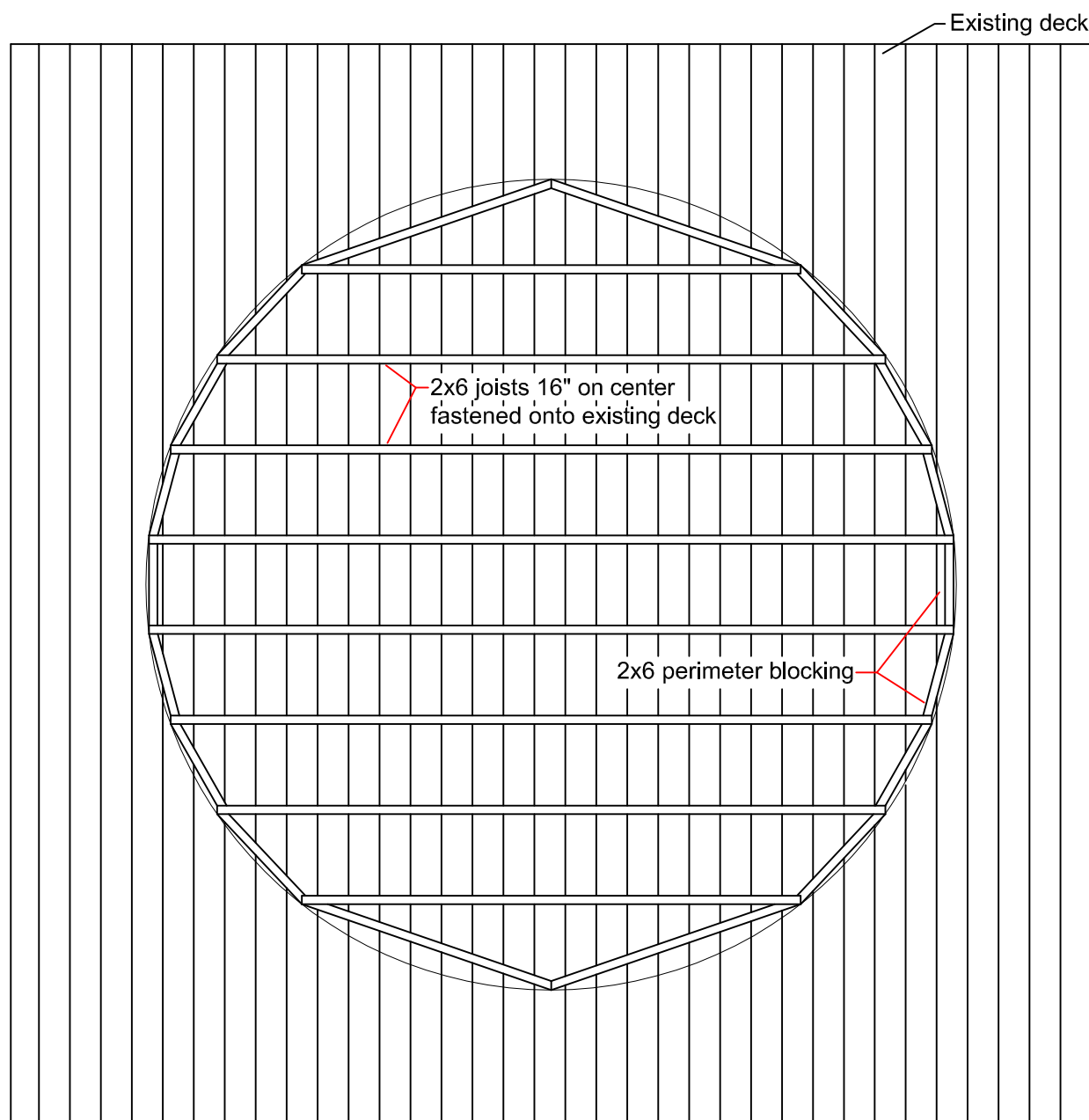

- 1) Mark 12 foot diameter circle onto existing decking.
- 2) Cut and install 2x6 joists 16" o.c. so that they do not extend beyond the 12' circle.
- 3) Cut and install 2x6 blocking so that it does not extend beyond the 12' circle.

# Plywood Layout

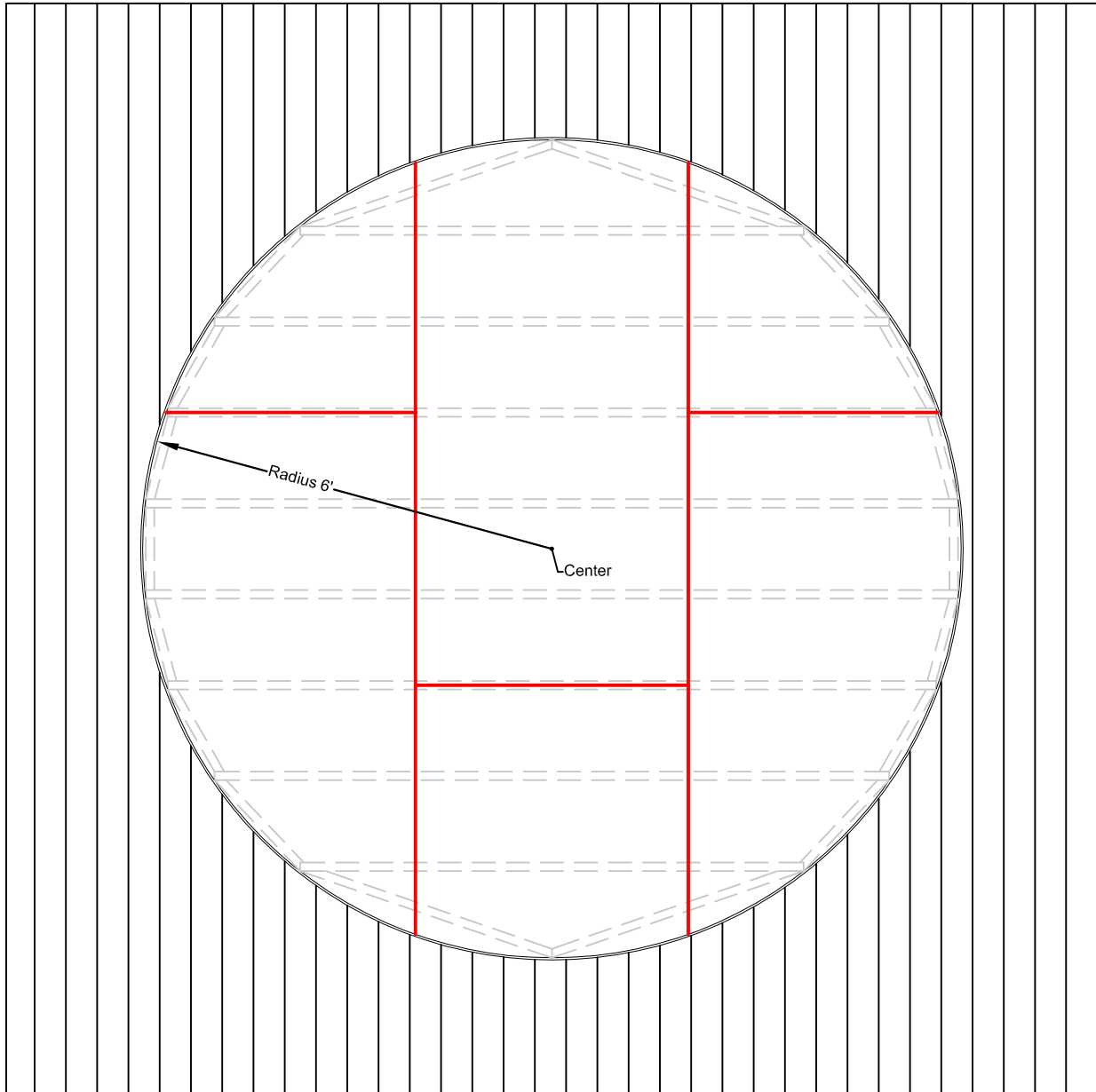

- 1) Fasten  $\frac{3}{4}$ " T&G plywood in layout as shown.
- 2) Mark 12 foot diameter circle onto plywood subfloor.
- 3) Install finished flooring (or 1x6 ring for floating floor) and cut both layers to exact diameter.
- 4) Install plywood drip edge along the outer circumference making sure 1" extends above floor level.

Finished floor inside yurt  
Note: Contact Pacific Yurts if you plan to use a floating floor system.

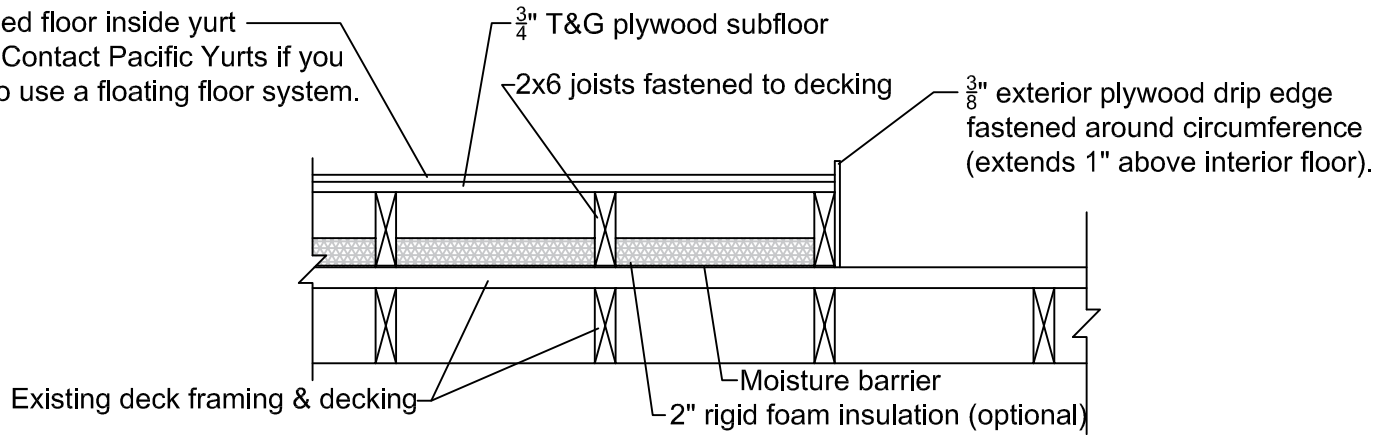

## PLATFORM SECTION

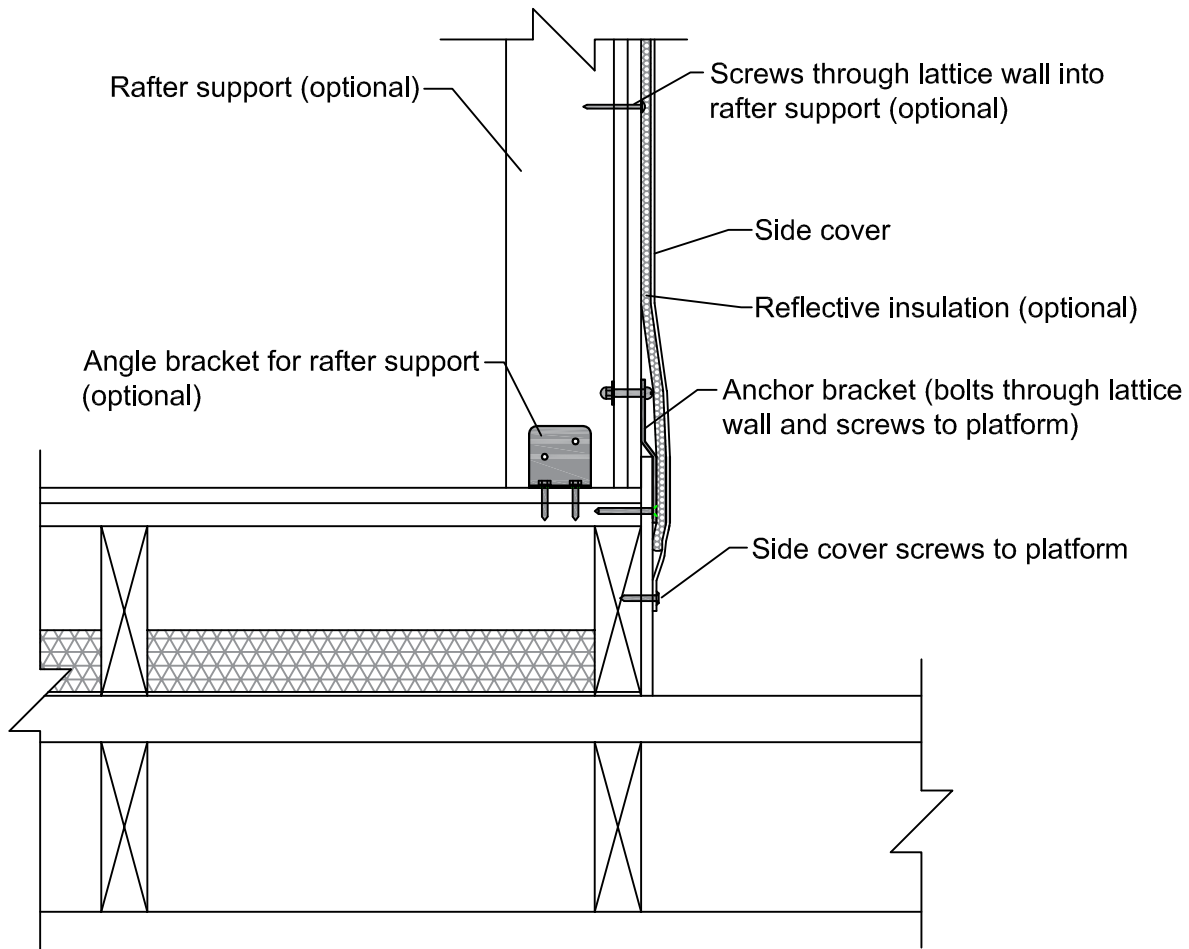

## YURT CONNECTION TO PLATFORM