

Suggested Platform Construction – 20' Yurt

Being what we call a 'soft' structure, the yurt reacts more readily to climatic conditions than do 'rigid' structures, therefore it is important to choose your site carefully and take into account prevailing wind patterns, overhead tree limbs, water runoff, etc. In general, the best site would be protected from the wind, would receive morning sun and afternoon shade and be free from overhead objects such as large dead tree limbs that could damage the yurt in heavy winds. Plan your entry so that the doorway faces away from prevailing winds.

For a secure and comfortable installation, a well-built platform is necessary. To ensure a weather proof installation the platform needs to be circular and the same diameter as the yurt so the side cover fabric can extend below the interior floor level. This will provide a draft-free and watertight seal. Any exterior decking should be separated from, or at a lower level than the yurt platform. Unless you are skilled, enlist the help of an experienced carpenter for building the platform.

The following plans show the typical construction of the yurt platform and are a suggestion only. Keep in mind that every site will be different, so the platform construction and footings should reflect the conditions of each individual site. The site and soil conditions and local building requirements will dictate the footing size and depth below grade. Check with your local building department to determine if you will need an engineered design for permit.

Notes:

- 1.** The total height of the drip edge should be at least 8" to protect the platform's beams. The bottom portion of the drip edge will be visible once the yurt is installed. It should be stained or painted to protect it and to match the exterior color scheme.
- 2.** The 1" portion of the drip edge that extends above floor level will be visible on the inside and can be painted or stained to match the interior color scheme.
- 3.** Plywood skirting (to prevent airflow beneath the floor) and a vapor barrier may also be desirable. Some building departments will require vent openings in the underfloor enclosure to prevent trapped moisture.
- 4.** If you plan to connect the yurt to an existing building (or another yurt) be sure to allow a minimum of 12" between the existing building and your yurt platform. A covered walkway can be built to connect the two after the yurt is installed.
- 5.** Keep in mind that the fabric windows open from the outside. If you plan to have the platform elevated you should consider adding a catwalk or exterior decking for window access.
- 6.** If you plan to install a "floating" floor on your platform, please contact Pacific Yurts for recommendations on how to prepare the platform.
- 7.** When using the 2x6 T&G flooring be sure it is kiln dried and has a low moisture content to avoid gaps as the wood dries.
- 8.** Consider incorporating insulation between the beams maintaining 1" air space from the underside of your flooring. Pacific Yurts recommends using rigid foam insulation with reflective side facing upward, however it is also possible to use other insulation materials.



20' Platform Construction Overview

- 1.) Lay out footings according to framing plan and level.

Notes:

- Poured concrete footings may be required. Consult a local contractor or engineer for proper determination and for local building requirements.
- If you purchase the Central Column option an additional footing will be necessary in the center of the platform.

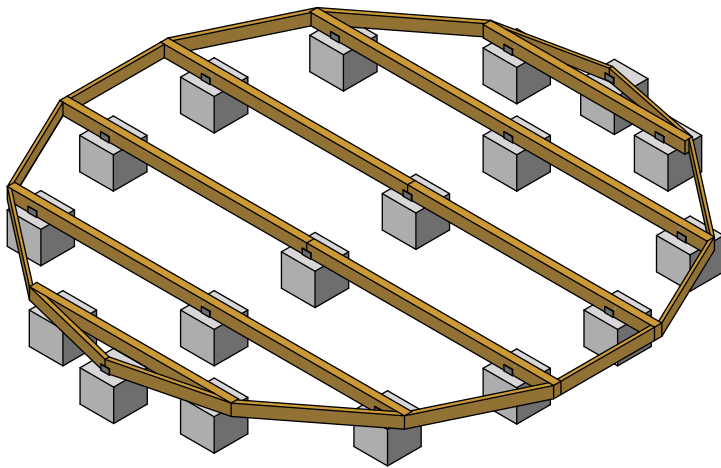
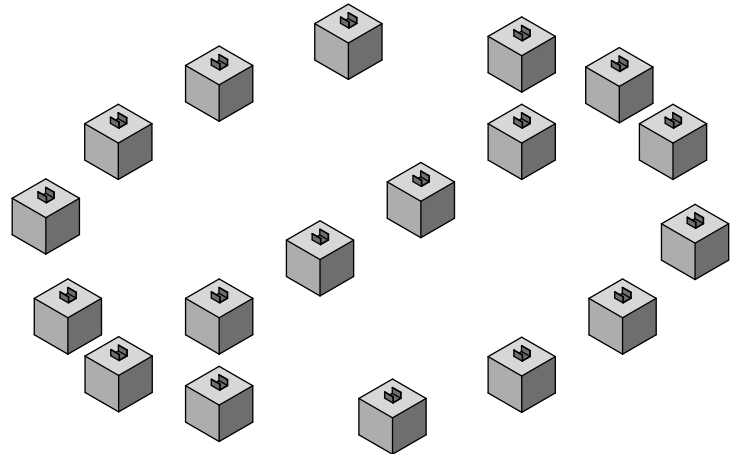

- 2.) Cut beams to length, level them, and fasten onto footings.
- 3.) Cut 2x6 perimeter blocking and fasten to beams.
- 4.) Install floor insulation (optional).

Notes:

- Diagram assumes level site. On sloping terrain vertical support posts and cross bracing may be necessary.
- If 1-1/8" plywood flooring is used we recommend adding 2x6 blocking between beams (four feet on center).
- If you plan to purchase the cable tie-down option an extra block will be needed in the center of the platform.

- 5.) Fasten flooring (1-1/8" plywood or 2x6 T&G) onto beams.
- 6.) Cut flooring into a circle with diameter matching that of the yurt.
- 7.) Cut 3/8" exterior plywood (OSB is best for small yurts) into strips of desired width and fasten around perimeter of flooring so that 1" protrudes above floor level. This is the plywood drip edge.
- 8.) Use caulking to provide a seal between flooring and drip edge.

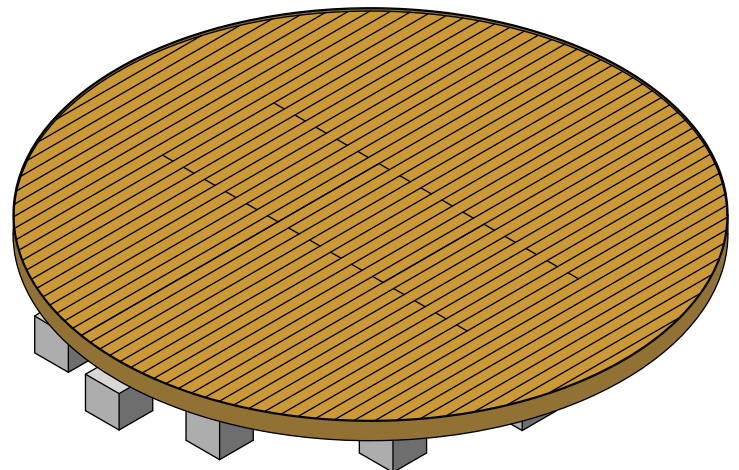

Typical 20' Platform Framing Plan

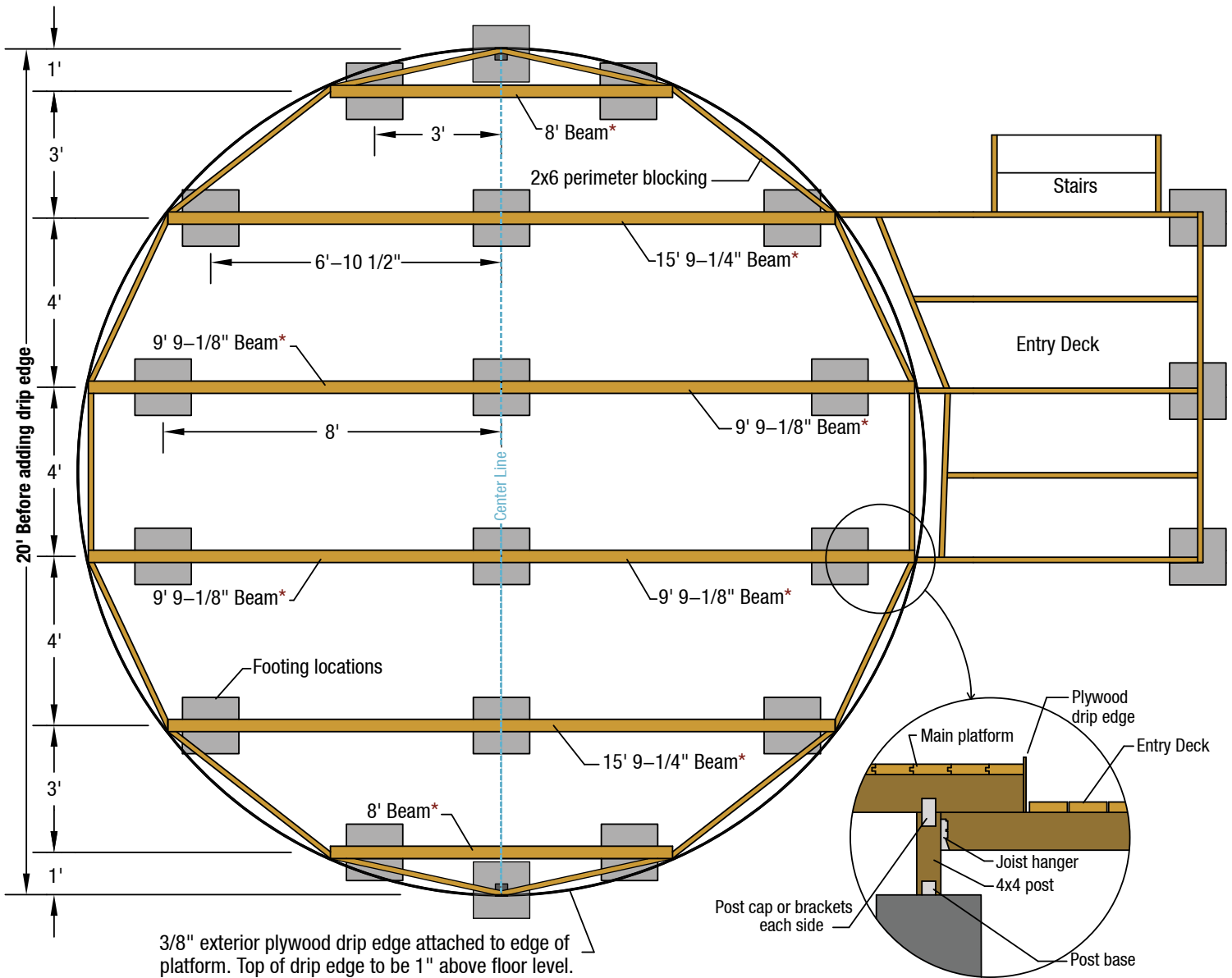

TYPICAL ELEVATION

Entry deck should be below the floor level of the yurt platform so as not to interfere with drip edge.

*4"x6" or 4"x8" beams may be appropriate, depending on use and conditions.

Notes:

- 1.) Platform construction and footings should reflect conditions of each individual site and local building requirements.
- 2.) 2x6 T&G or 1-1/8" plywood flooring to be laid perpendicular to beams and trimmed to the same diameter as that of the yurt.
- 3.) 20' diameter measurement does not include the drip edge.
- 4.) Site and soil conditions and local building requirements will dictate footing size and depth below grade.
- 5.) Footings may need to be embedded in the ground to below the local frost depth, and should extend 6" above ground surface minimum.

Typical Platform Elevation

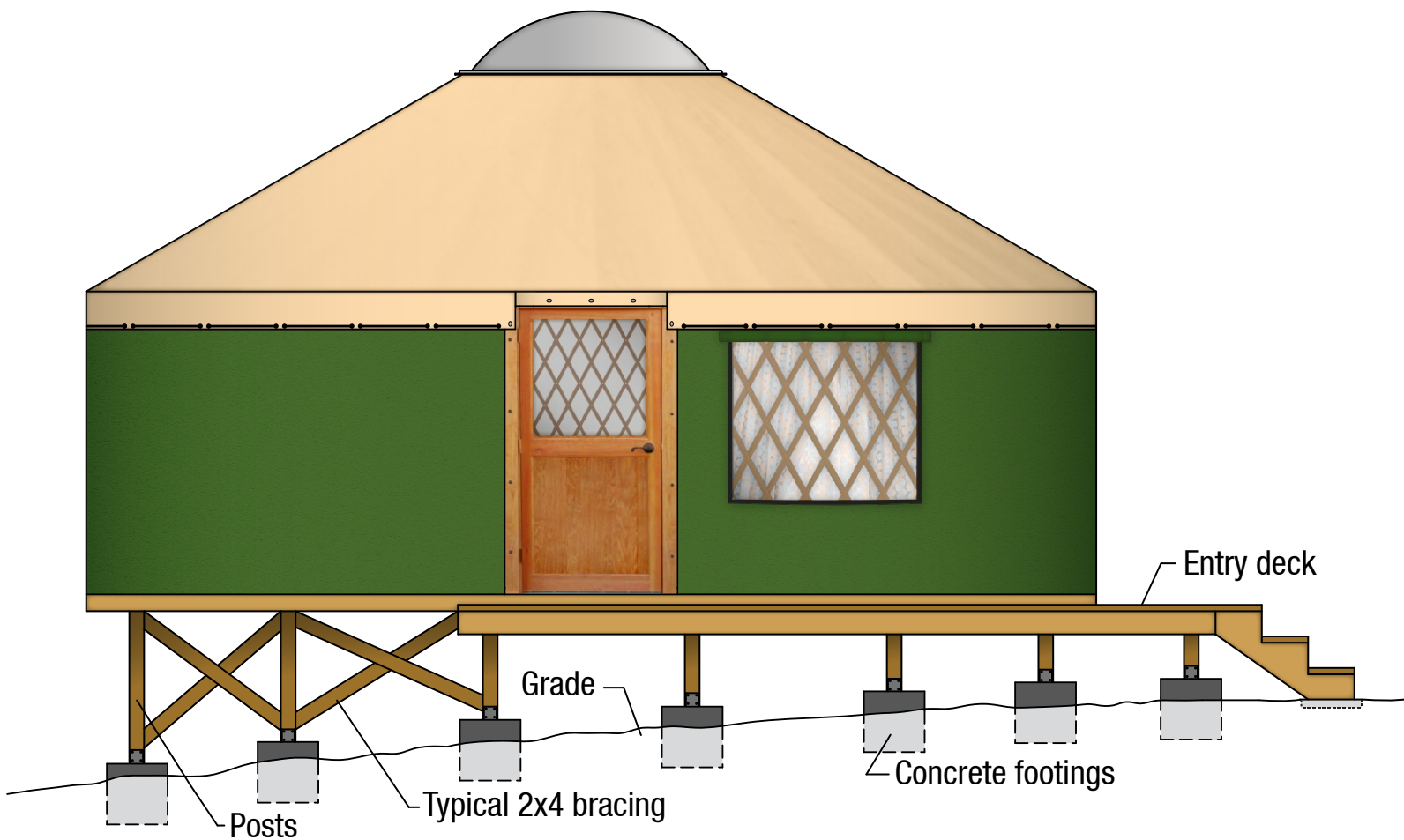

Note: Platform and footings should be designed according to the conditions of each individual site and local building requirements. Site and soil conditions will dictate footing size and depth below grade.

2x6 T&G Layout – 20' Yurt

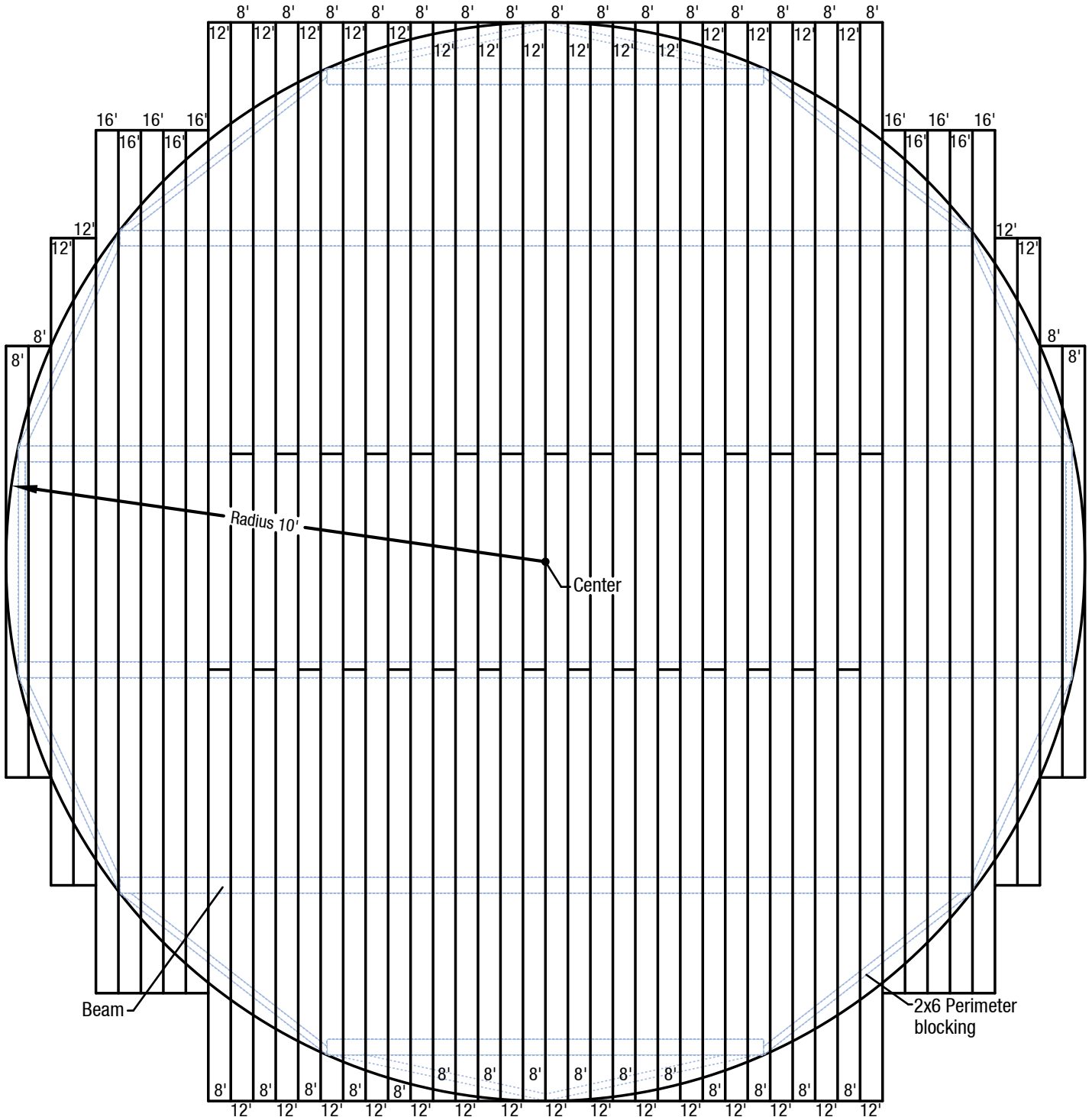

1.) Make a compass using a board or non-stretch string and a nail at the center to mark radius.

2.) Using a sharp circular saw carefully cut the platform to exactly 20 feet in diameter.

Note: 2x6 T&G is often used for open beam ceilings and may have a V-groove which should face down so as not to catch debris and make floor sweeping difficult.

Plywood Layout – 20' Yurt

Note: Due to the tongue and groove on 1-1/8" plywood you may need to laminate a small piece of scrap to one edge in order to achieve the full diameter.

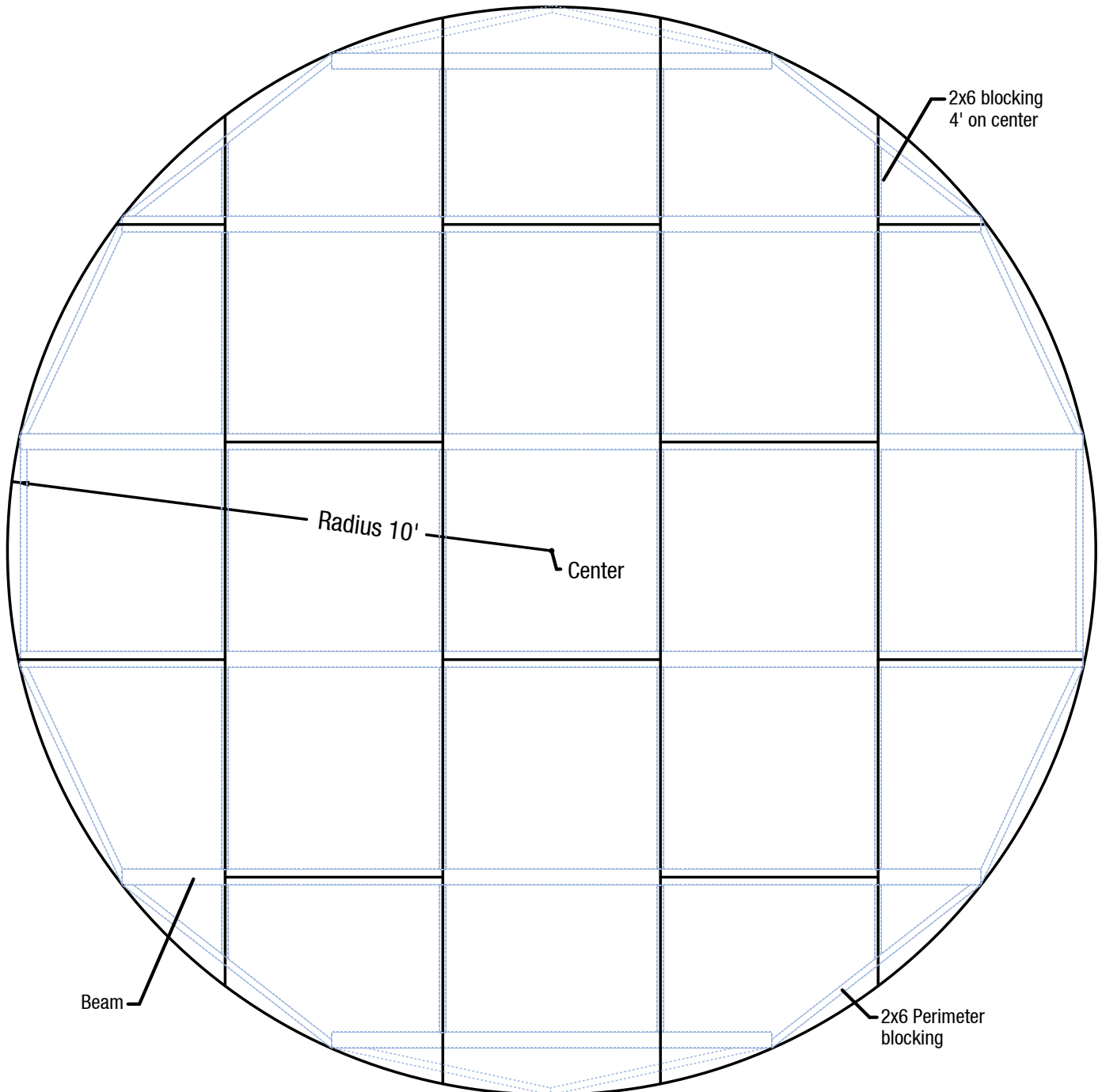

- 1.) Make a compass using a board or non-stretch string and a nail at the center to mark radius.
- 2.) Using a sharp circular saw carefully cut the platform to exactly 20 feet in diameter.

Plan View

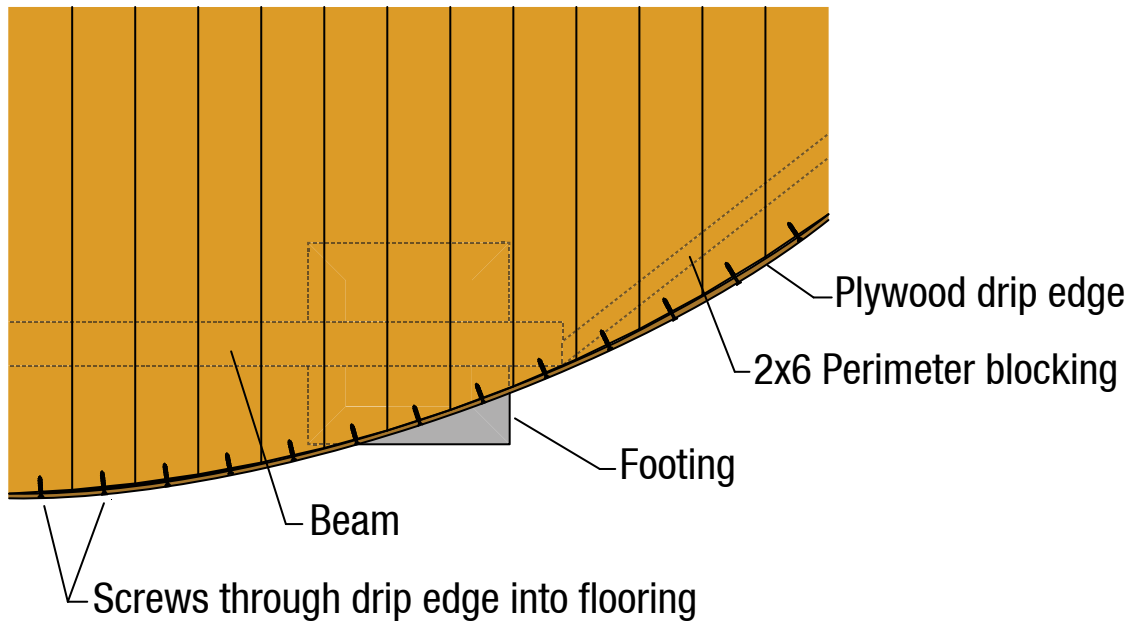

Elevation

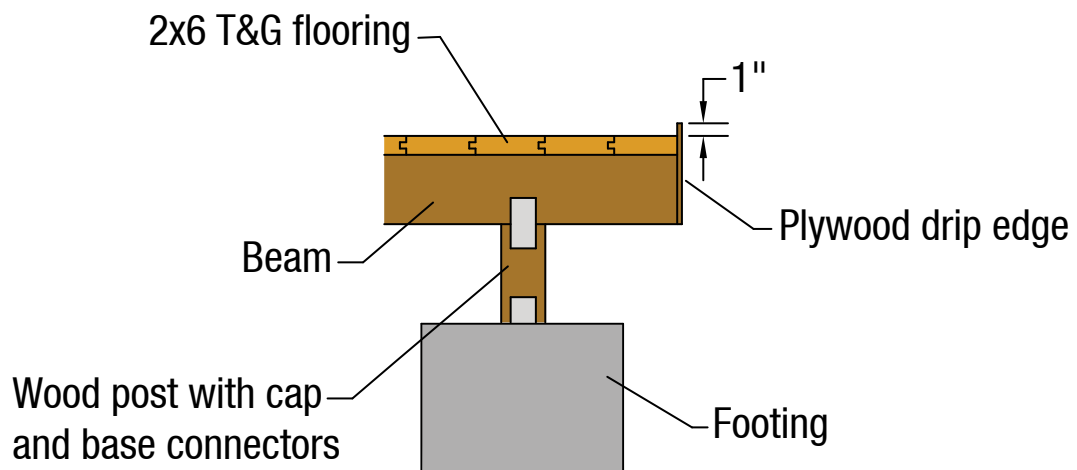

20' Diameter Yurt Platform Materials List

Note: This materials list represents the minimum amount of lumber required for a basic circular platform on flat level ground. It does not include any exterior deck/porch materials, insulation or footings. For sloped sites or to elevate the platform you will need to add posts and cross bracing.

Platform Materials (2x6 T&G Flooring Option)		
Material	Quantity	Use
2x6 Kiln Dried T&G 'Select Deck'	27 @ 16' 34 @ 12'	Platform Flooring
2x6 Standard & Better	6 @ 10' 1 @ 8'	Perimeter Blocking
4x6 or 4x8 Standard & Better	2 @ 16' 4 @ 10' 2 @ 8'	Beams
3/8" Exterior Plywood Siding (no groove)	2 Sheets (4' x 8')	Plywood Drip Edge

Platform Materials (1-1/8" Plywood Flooring Option)		
Material	Quantity	Use
1-1/8" T&G Plywood	12 Sheets (4' x 8')	Platform Flooring
2x6 Standard & Better	8 @ 10' 7 @ 8'	Blocking
4x6 or 4x8 Standard & Better	2 @ 16' 4 @ 10' 2 @ 8'	Beams
3/8" Exterior Plywood Siding (no groove)	2 Sheets (4' x 8')	Plywood Drip Edge